

Article number: 40600705222445

Description: Helical gearbox
C703F-52,2-P112B5

Measures

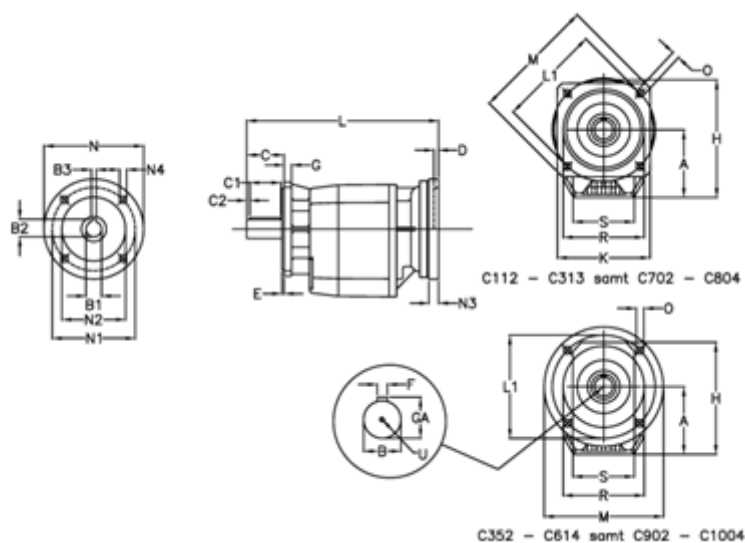

A = 208.0	D = 4.5	L1 = 300	R = 262
B = 60	E = 5	M = 350	S = 250
B1 = 28	F = 18	N = 250	U = M20x42
B2 = 31.3	G = 17	N1 = 215	
B3 = 8	GA = 64.0	N2 = 180	
C = 120	H = 358.0	N3 = 0	
C1 = 90	K = 300	N4 = M12x16	
C2 = 15	L = 483.0	O = 18.0	